



## Type VRFB90 needle valves

- Bidirectional

Technical specifications and diagrams are measured with mineral oil of 46 cSt viscosity at 40°C (104°F) temperature.

	<b>VRFB9001</b>	<b>VRFB9002</b>	<b>VRFB9003</b>	<b>VRFB9004</b>	<b>VRFB9005</b>
Nominal flow	30 l/min (7.9 US gpm)	40 l/min (10.6 US gpm)	50 l/min (23.8 US gpm)	80 l/min (21.1 US gpm)	110 l/min (29.1 US gpm)
Max. pressure	350 bar (5100 psi)	350 bar (5100 psi)	350 bar (5100 psi)	320 bar (4600 psi)	300 bar (4350 psi)
Fluid	mineral based oil				
Viscosity	from 10 to 200 cSt				
Max. level of contamination	18/16/13 ISO4406				
Fluid temperature	with NBR seals from -30°C (-22°F) to 80°C (176°F)				
Environmental temperature for working conditions	from -40°C (-40°F) to 100°C (212°F)				
Weight	steel 0.34 kg (0.75 lb)	0.34 kg (0.75 lb)	0.43 kg (0.95 lb)	1.13 kg (2.49 lb)	1 kg (2.2 lb)

NOTE - For different conditions, please contact Walvoil Sales Dpt.

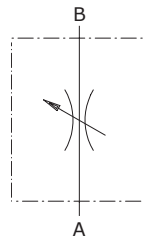

### Dimensions

Dimensions are in mm-in

Valve type	All ports	A	B	C	D	E
VRFB9001	G1/4	58 - 2.28	82 - 3.23	25 - 0.98	30 - 1.18	M25X1.5
VRFB9002	G3/8	60 - 2.36	82 - 3.23	25 - 0.98	30 - 1.18	M25X1.5
VRFB9003	G1/2	64 - 2.52	88 - 3.46	30 - 1.18	30 - 1.18	M25X1.5
VRFB9004	G3/4	89 - 3.50	116 - 4.57	40 - 1.57	42 - 1.65	M35X1.5
VRFB9005	G1	89 - 3.50	116 - 4.57	40 - 1.57	42 - 1.65	M35X1.5

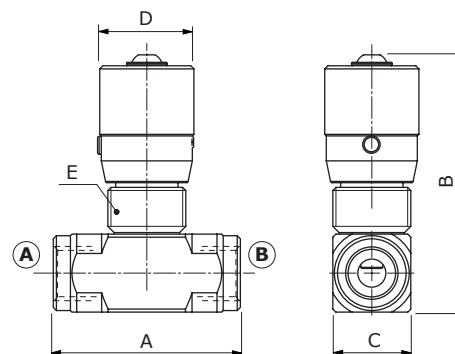

### Ordering codes and description composition

VRBF90 01 └─ Port size

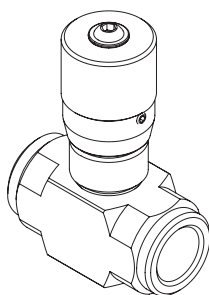

#### VRFB90 complete valves

TYPE	CODE	DESCRIPTION
VRFB9001	1605210100	Steel body, G1/4 ports
VRFB9002	1605220100	Steel body, G3/8 ports
VRFB9003	1605230100	Steel body, G1/2 ports
VRFB9004	1605240100	Steel body, G3/4 ports
VRFB9005	1605250100	Steel body, G1 ports

For different configurations or SAE thread please contact our Sales Dpt.

### Rating diagram

**VRFB9001**  
pressure drop vs. flow

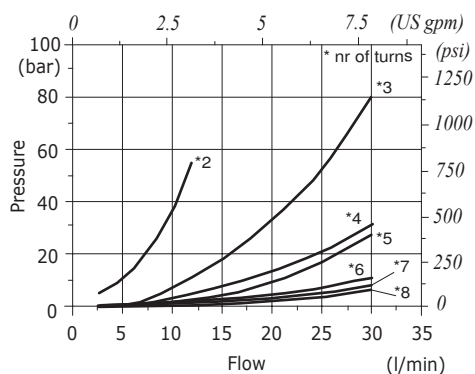

**VRFB9002**  
pressure drop vs. flow

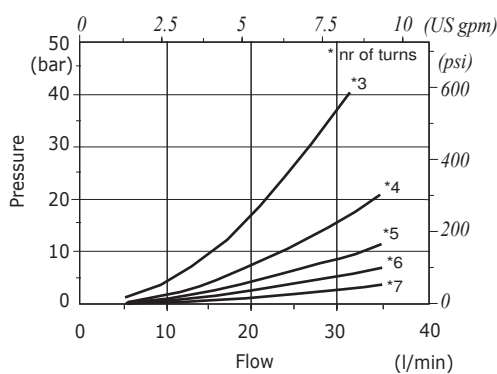

**VRFB9003**  
pressure drop vs. flow

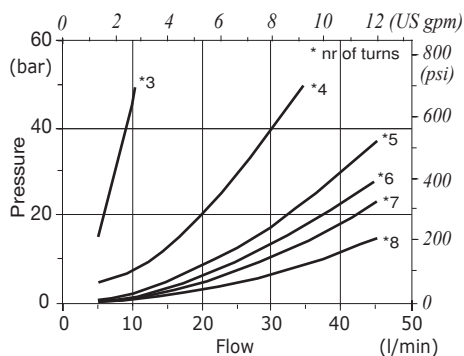

**VRFB9004**  
pressure drop vs. flow

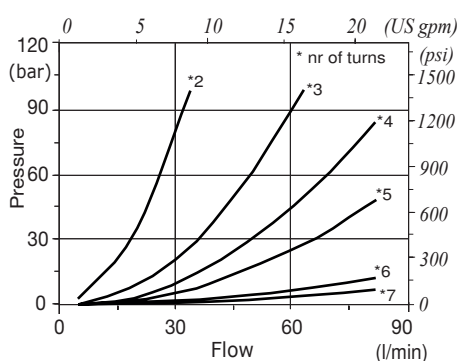

**VRFB9005**  
pressure drop vs. flow

